

CVI338RX3



Produktfamilie	Weinlagerschrank
Installation	Einbaugerät
Nischenhöhe in cm	82-87 cm
Abtausystem	Automatisch
Kühlsystem	Dynamische Umluftkühlung
Scharniersystem	Standard
Türanschlag	Rechts



Eigenschaften Weinlagerfach



Anzahl der geprägten Flaschenablagen	2
Anzahl der variablen Flaschenablagen	3
Material der variablen Flaschenablagen	Eichenholz
Flaschenablagen auf Telekopauszügen	Ja
Innenbeleuchtung	LED
Innenraumluftfilter	Aktivkohle

Programme / Funktionen



Art der Bedienung	Touch-Control	Tastensperre/Kindersicherung	Ja
Position der Bedienung	Intern im Weinlagerfach	LED-Innenbeleuchtung	Variabel regelbar
Ausführung des Displays	LED	Dynamische Umluftkühlung	Ja
Displayanzeige	Temperaturalarm, Temperaturanzeige	Temperaturalarm	Ja
Funktionsanzeige	Ja	Türalarm	Ja

Technische Eigenschaften

Regelbare Temperaturzonen	2	Anzahl der Kompressoren	1
Unabhängige Kühlsysteme	2	Kompressor	Vibrationsreduziert
		Kältemittel	R600a

Anzahl der Türgverglasungen	2	Füllmenge des Kältemittels	20 g
Temperaturregelbereich	+5 bis +20 °C	Material der Isolierung	Cyclopentan
Temperatursteuerung	Elektronisch	Material der Geräterückwand	Metall
UV-Licht geschützte Doppelverglasung	Ja	Höhenregulierbare Stellfüße	Vorne und hinten
Abtauheizung	Ja		

Technische Daten / Energielabel - ab 1.3.2021









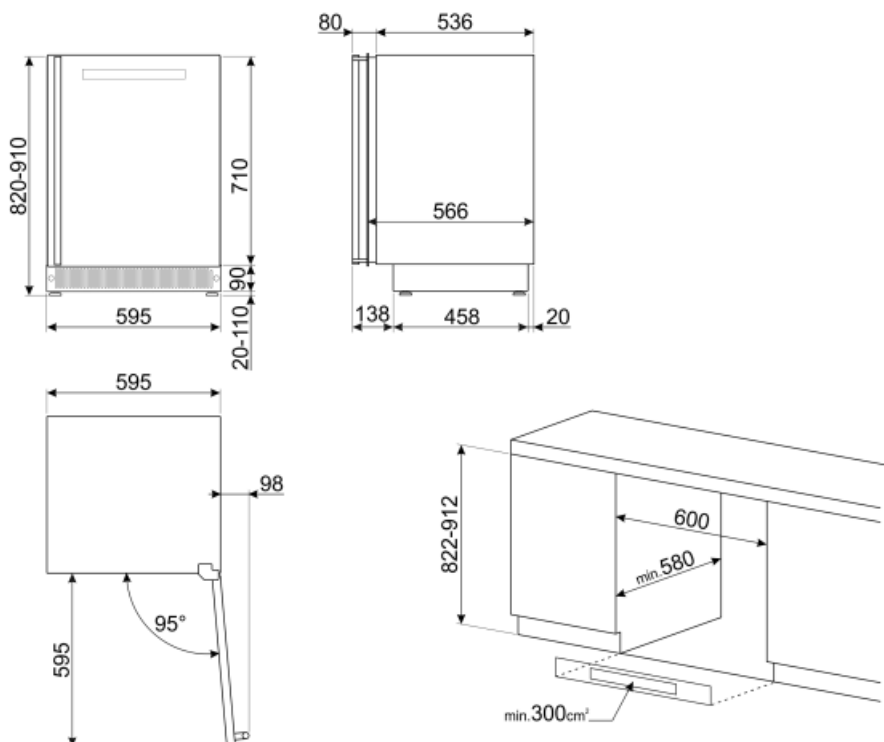

Jährlicher Energieverbrauch	140 kWh/Jahr	Summe der Rauminhalte der Kaltlagerfächer und der Kühlfächer	114 l
Energieeffizienzklasse	G	Klimaklassen	SN, N, ST
Luftschallemissionsklasse	C	EI	165 %
Nutzzinhalt total	114 l		

Elektrischer Anschluss

Netzstecker	(F;E) Schuko	Spannung	220-240 V
Elektrischer Gesamtanschlusswert	40 W	Frequenz	50 Hz
Absicherung	0.4 A	Länge des Netzkabels	150 cm



Symbols glossary (TT)

-  A: Product drying performance, measured from A+++ to D / G depending on the product family
-  LED display: to show programmes, functions and options selected and the time to the end of the cycle.
-  Fingerprint proof stainless steel: Fingerprint proof stainless steel keeps stainless steel looking as good as new.
-  Nischenhöhe 82-87 cm
-  Energy efficiency class G
-  The automatic defrost system works by automatically defrosting at regular intervals eliminating the need to defrost altogether.
-  Ventilated: Forced distribution of cold air in the refrigerator compartment, which allows even temperature distribution within the fridge.
-  LED interior lighting: is a more energy efficient and long lasting way of illuminating the interior of the appliance.
-  Touch controls: Easy to use touch controls allow the appliance to be programmed at the touch of a button.