

FMI120N2





Nutzbares Garraumvolumen 20 l



Produktfamilie	Mikrowelle
Produktkategorie	Einbaugerät
Installation	Mit Rahmen
Energiequelle	Elektrisch
Kochmethode	Mikrowelle mit Grill
Regelung des Garraums	Elektronisch



Programme / Funktionen

Garfunktionen	5
Großflächengrill	
Auftauen nach Zeit	
Auftauen nach Gewicht	
Mikrowelle	
Mikrowelle + Grill	
Automatikprogramme	3
Sonderfunktionen Mikrowelle	Persönliche Rezepte

Bedienelemente



Display-Technologie	TFT	Türöffnung	Touch-Türöffnung
Bedienelemente	Touch-Control		

Optionen



Zeitschaltautomatik	Elektronisch	Demo-Mode Showroom-Funktion	Ja
Programmierung der Garzeit	Garzeit-/Programmende	Tastensperre/Kindersicherung	Ja
Akustisches Signal bei Garzeitende	Ja		

Leistungsbegrenzung Ja

Funktion Quick Start Ja

Technische Eigenschaften

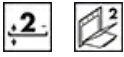

Material des Garraums	Edelstahl	Art des Grills	Quarz
Anzahl der Garebenen	2	Leistung des Grills	1000 W
Art der Einschubschienen	Erhöhter Rundrost	Türöffnung	Türöffnung seitlich
Anzahl der Beleuchtungen	1	Anzahl der Türverglasungen	2
Art der Beleuchtung	Glühlampe	Kühlsystem	Querstromlüfter
Leistung der Beleuchtung	20 W	Mikrowellen- Schutzschild	Ja
Glas-Drehteller	Ja	Sicherheitsabschaltung der Mikrowelle bei Türöffnung	Ja
Drehteller Ø	24,5 cm	Nutzabmessungen des Garraums (HxBxT)	210x305x280 mm
Garraumbeleuchtung bei Türöffnung	Ja	Leistung Mikrowelle	800 W

Serienzubehör

Erhöhter Rundrost 1

Einbaurahmen Ja

Elektrischer Anschluss

**Elektrischer
Gesamtanschlusswert** 1300 W

Absicherung 5.2 A

Spannung 230 V

Frequenz 50 Hz

Länge des Netzkabels 150 cm

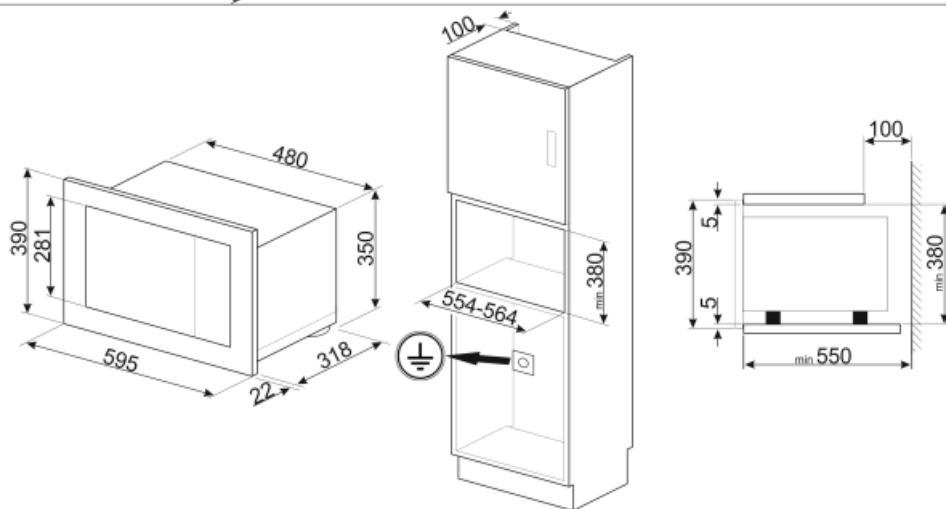
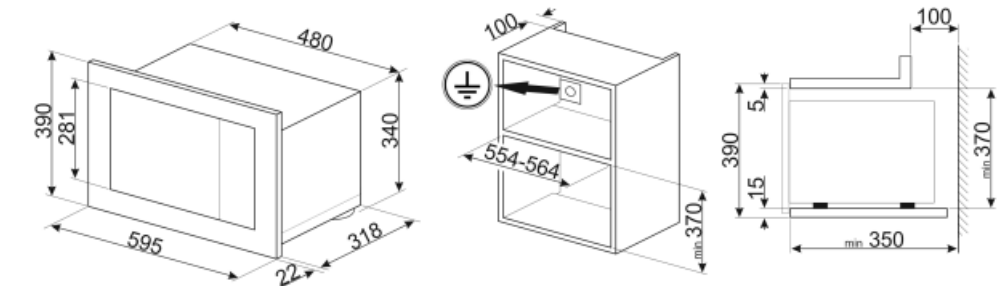











Sonderzubehör

KITPLATE



The dish baker is a Teflon-coated aluminum plate with the lower part of ferrous material immersed in a silicone rubber 26,5 cm edges of the flare, 25 cm base

Symbols glossary (TT)

- | | |
|--|--|
|  <p>Kindersicherung: Einige Modelle sind mit einer Tastensperre ausgestattet, die eine versehentliche Änderung des Programms sperrt.</p> |  <p>Microwave energy shortens cooking times dramatically and produces energy savings.</p> |
|  <p>Defrost by time: Manual defrost function. At the end of the set duration, the function stops.</p> |  <p>Defrost by weight: Automatic defrost function. You choose the type of food to defrost from the available categories (MEAT - FISH - BREAD - DESSERTS) After entering the weight of the food, the oven automatically defines the time required for proper defrosting.</p> |
|  <p>Double glazed doors: Number of glazed doors.</p> |  <p>Grill: Very intense heat coming only from above from a double heating element. The fan is not active. Provides excellent grilling and gratinating results. Used at the end of cooking, it gives a uniform browning to dishes.</p> |
|  <p>Microwave: Penetrating straight into the food, microwaves cook very quickly and with considerable energy savings. Suitable for cooking without fat, they are also able to thaw and heat food without altering its original appearance and aroma. The microwave function can also be combined with conventional functions with all the resulting advantages. Ideal for all types of food.</p> |  <p>Microwave + grill element: The use of the grill results in a perfect browning of the surface of the food. The action of microwaves allows instead of cooking in a short time the internal part of the food.</p> |
|  <p>The oven cavity has 2 different cooking levels.</p> |  <p>Touch controls: Easy to use touch controls allow the appliance to be programmed at the touch of a button.</p> |
|  <p>The capacity indicates the amount of usable space in the oven cavity in litres.</p> | |