

SE364EMTB



Produktfamilie	Kochfeld
Einbau	Auflage
Breite	60 cm
Energiequelle	Strom
Typ der Heiztechnik	Glaskeramik
EAN-Code	8017709234768



Design



Farbe	Schwarz
Oberfläche	Glas
Design	Neutrales Design
Material	Glas
Glasart	Glaskeramik
Typ der Glaskeramik	Facettenschliff
Bedienung	Sensor Touch-Control
Position der Bedienelemente	Frontal
Farbe des Siebdrucks	Grau

Programme / Funktionen



Anzahl der Kochzonen	4
Anzahl der Keramik-Kochzonen	4
Anzahl der Kochzonen mit Booster	4
Ein/Aus-Taste	Ja
Leistungsstufen	9

Optionen



Ausschnittmass	490x560 mm	Eco-Logic - Reduzierung der Anschlussleistung	Ja
----------------	------------	---	----

Sensor-Warmhalteautomatik	Ja	Eco-Logic - Reduzierung der Anschlussleistung	2800, 4000 W
Timer mit Endabschaltung	4	Demo-Mode Showroom-Funktion	Ja
Timer/Minutenzähler	1	Tastensperre/Kindersicherung	Ja
Akustisches Signal bei Garzeitende	Ja	Schnellstart	Ja
Restzeitanzeige	Ja		

Technische Eigenschaften



Vorne links - Glaskeramik - Zweikreiskochzone - 0.80 - 2.00 kW - Ø 12.4 - Ø 18.4 cm

Hinten links - Glaskeramik - 1.20 kW - Ø 14.8 cm

Hinten rechts - Glaskeramik - Erweiterbar - 1.10 - 2.00 kW - Ø 14.8 - 25.3x14.8 cm

Vorne rechts - Glaskeramik - 1.20 kW - Ø 14.8 cm

Überhitzungsschutz	Ja	Restwärmeanzeige	Ja
Auto-Stop Flüssigkeit-/Überlaufschutz	Ja		

Elektrischer Anschluss

Elektrischer Gesamtanschlußwert	6400 W	Typ des Netzkabels	Ein- und zweiphasig
Absicherung	19 A	Frequenz	50/60 Hz
Spannung	220-240 V	Länge des Netzkabels	150 cm
Spannung	380-415 V	Anschlussleiste	6-polig

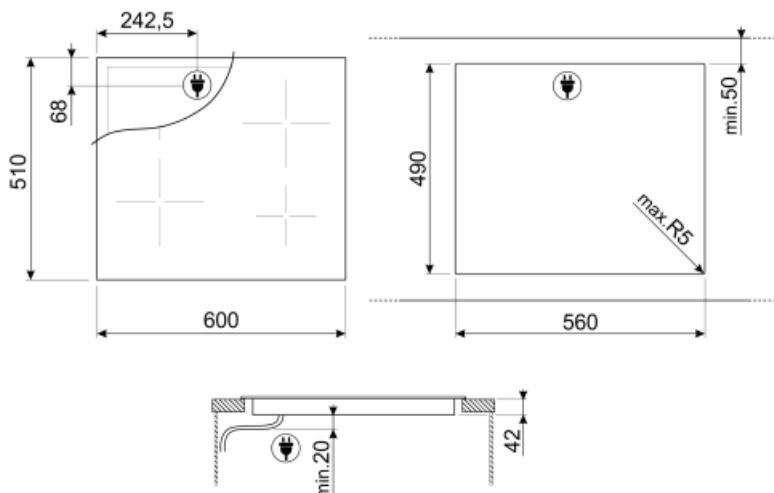













Sonderzubehör



SCRP

Metall-Glasschaber für alle Glaskeramik-/Induktionskochfelder

Symbols glossary (TT)

 <p>Power booster: option allows the zone to work at full power when very intense cooking is necessary.</p>	 <p>Ultra-low profile: Installation of product with flat edge - height of 1 mm.</p>
 <p>Kindersicherung: Einige Modelle sind mit einer Tastensperre ausgestattet, die eine versehentliche Änderung des Programms sperrt.</p>	 <p>ECO-logic: option allows you to restrict the power limit of the appliance real energy saving.</p>
 <p>This function allows you to keep cooked food warm without burner it</p>	 <p>Overheat protection: The safety system that automatically turns off the hob in case of overheating of the control unit.</p>
 <p>Glass ceramic: The base of the hob is made glass ceramic. Heating is performed by the heating elements Hi-Light.</p>	 <p>Overfill protection: The special overfill protection shuts down the stove in the presence of overflow of liquids.</p>
 <p>Quick Start function: the chosen temperature is reached faster. The heating element works at maximum power until the right temperature is reached.</p>	 <p>Indication of residual heat: After the glass ceramic hob is switched off the residual heat indicator shows which of the heating zones still remains hot. When the temperature drops below 60 ° C, the indicator goes out.</p>
 <p>Time elapsed: shows how long the cooking zone has been in use.</p>	 <p>Timer: All ceramic hobs have a timer which automatically ends cooking after a preset time.</p>
 <p>Touch control</p>	