

SE385EMTB



Produktfamilie	Kochfeld
Einbau	Auflage
Breite	80 cm
Energiequelle	Strom
Typ der Heiztechnik	Glaskeramik
EAN-Code	8017709234751



Design



Farbe	Schwarz
Oberfläche	Glas
Design	Neutrales Design
Material	Glas
Glasart	Glaskeramik
Typ der Glaskeramik	Facettenschliff
Bedienung	Sensor Touch-Control
Position der Bedienelemente	Frontal
Farbe des Siebdrucks	Grau

Programme / Funktionen



Anzahl der Kochzonen	5
Anzahl der Keramik-Kochzonen	5
Anzahl der Kochzonen mit Booster	5
Leistungsstufen	9

Optionen



Ausschnittmass	490x745 mm	Eco-Logic - Reduzierung der	Ja
Sensor-Warmhalteautomatik	Ja	Anschlussleistung	

Timer mit Endabschaltung	5	Eco-Logic - Reduzierung der Anschlussleistung	2800, 4000 W
Timer/Minutenzähler	1	Demo-Mode Showroom-Funktion	Ja
Akustisches Signal bei Garzeitende	Ja	Tastensperre/Kindersicherung	Ja
Restzeitanzeige	Ja	Schnellstart	Ja

Technische Eigenschaften



Vorne links - Glaskeramik - Ø 18.4 cm

Hinten links - Glaskeramik - Ø 14.8 cm

Mitte - Glaskeramik - Erweiterbar - 1.40 - 2.20 kW - Ø 17.0 - 26.5x17.0 cm

Vorne rechts - Glaskeramik - Zweikreiskochzone - 1.00 - 2.20 kW - Ø 14.8 - Ø 21.4 cm

Vorne rechts - 1.20 kW - Ø 14.8 cm

Überhitzungsschutz Ja

Restwärmeanzeige Ja

Auto-Stop Flüssigkeit-Überlaufschutz Ja

Elektrischer Anschluss

Elektrischer Gesamtanschlußwert	8600 W
Absicherung	24 A
Spannung	220-240 V
Spannung	380-415 V

Typ des Netzkabels	Ein- und zweiphasig
Frequenz	50/60 Hz
Länge des Netzkabels	150 cm
Anschlussleiste	6-polig

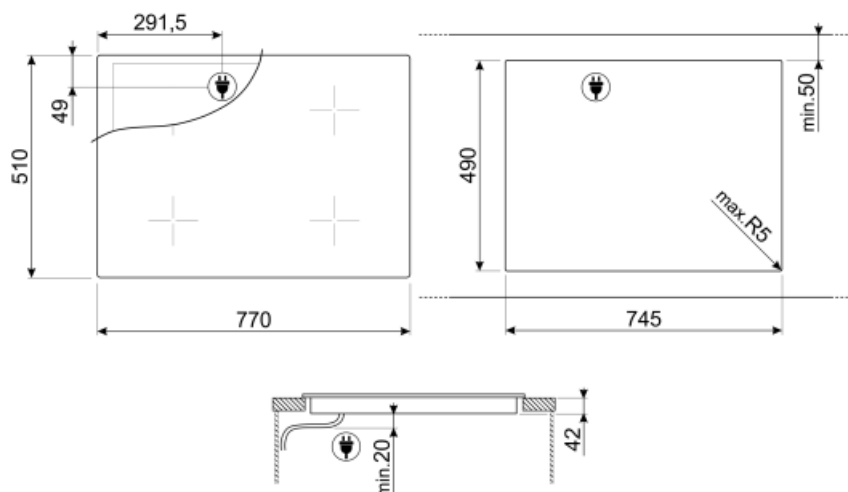













Sonderzubehör



SCRP

Metall-Glasschaber für alle Glaskeramik-/Induktionskochfelder

Symbols glossary (TT)

 <p>Power booster: option allows the zone to work at full power when very intense cooking is necessary.</p>	 <p>Ultra-low profile: Installation of product with flat edge - height of 1 mm.</p>
 <p>Kindersicherung: Einige Modelle sind mit einer Tastensperre ausgestattet, die eine versehentliche Änderung des Programms sperrt.</p>	 <p>ECO-logic: option allows you to restrict the power limit of the appliance real energy saving.</p>
 <p>This function allows you to keep cooked food warm without burner it</p>	 <p>Overheat protection: The safety system that automatically turns off the hob in case of overheating of the control unit.</p>
 <p>Glass ceramic: The base of the hob is made glass ceramic. Heating is performed by the heating elements Hi-Light.</p>	 <p>Overfill protection: The special overfill protection shuts down the stove in the presence of overflow of liquids.</p>
 <p>Quick Start function: the chosen temperature is reached faster. The heating element works at maximum power until the right temperature is reached.</p>	 <p>Indication of residual heat: After the glass ceramic hob is switched off the residual heat indicator shows which of the heating zones still remains hot. When the temperature drops below 60 ° C, the indicator goes out.</p>
 <p>Time elapsed: shows how long the cooking zone has been in use.</p>	 <p>Timer: All ceramic hobs have a timer which automatically ends cooking after a preset time.</p>
 <p>Touch control</p>	